

Samuel Bentham's Panopticon

Philip Steadman ^{1,*}

How to cite: Steadman, P. 'Samuel Bentham's Panopticon.' *Journal of Bentham Studies*, 2012, 14(1): 2, pp. 1–30. DOI: <https://doi.org/10.14324/111.2045-757X.044>.

Published: 01 January 2012

Peer Review:

This article has been peer reviewed through the journal's standard double blind peer review.

Copyright:

© 2012, The Author(s). This is an Open Access article distributed under the terms of the Creative Commons Attribution-Non Commercial- No Derivatives 2.0 International License (CC BY-NC-ND 2.0) <https://creativecommons.org/licenses/by-nc-nd/2.0/>, which permits re-use, distribution and reproduction in any medium, provided the original material is not modified, is not used for commercial purposes, and the original author and source are credited • DOI: <https://doi.org/10.14324/111.2045-757X.044>

Open Access:

Journal of Bentham Studies is a peer-reviewed open access journal.

*Correspondence: j.p.steadman@ucl.ac.uk

¹ UCL, UK

Samuel Bentham's Panopticon

PHILIP STEADMAN

Bartlett School (Faculty of the Built Environment), University College London

j.p.steadman@ucl.ac.uk

Credit for devising the Panoptical 'inspection principle' for prison design is attributed, perhaps now irrevocably, to Jeremy Bentham. However Jeremy always insisted that the original conception came from his younger brother Samuel – 'After all, I have been obliged to go a-begging to my brother, and borrow an idea of his'.¹ Samuel was to have been an equal partner in the running of Jeremy's Panopticon penitentiary. What is more, while Jeremy failed to get the penitentiary built in England despite twenty years' lobbying and a large expense of his own money, Samuel actually erected a Panoptical 'school of arts' in Russia in 1807. In this paper I describe this remarkable Russian building, which has received only passing mention in the literature of architectural history and Bentham studies. The building admittedly in its short life had little influence outside Russia; but it anticipated in its geometry the many 'radial prisons' built across the world in the later Nineteenth Century. Indeed Samuel's design avoided some of the contradictions that beset Jeremy's own detailed penitentiary scheme of 1791 – contradictions which led to the failure of several of those prisons that put Jeremy's plan directly into practice.

Keywords: Jeremy Bentham; Samuel Bentham; School of Arts; Panopticon; Russia; prison architecture

The Bentham brothers in Russia

In 1785 Jeremy Bentham travelled to Russia to visit Samuel, who was working for Prince Potemkin at Krichev, on the river Dnieper in the southern province of Mogilev, where the prince had an extensive estate.² Samuel Bentham had trained in Britain in the Navy's dockyards as a shipwright and engineer, and had then joined the service.³ In 1780 he was sent, with financial support from his father, on a fact-finding tour of dockyards on the Continent, ending up in St Petersburg where he met Potemkin.

¹ *The Works of Jeremy Bentham* ed. J. Bowring, 11 vols. Edinburgh, 1838–43 (henceforth 'Bowring'), x. p. 165

² For an account of Jeremy's journey, and the time that the brothers spent together at Krichev, see I.R. Christie, *The Bentham's in Russia 1780-1791*, Oxford, 1993, especially p. 177 where the Panopticon is discussed.

³ For Samuel Bentham's biography see Mary Sophia Bentham, 'Memoir of the late Brigadier-General Sir Samuel Bentham, with an Account of His Inventions', *Papers and Practical Illustrations of Public Works of Recent Construction both British and American*, London, 1856 pp. 41–79; and Mary Sophia Bentham, *The Life of Brigadier-General Sir Samuel Bentham, K.S.G.*, London, 1862.

Much impressed by his capacities and character, Potemkin made Samuel a lieutenant colonel and put him in command of a battalion stationed at Krichev with the purpose of training the men as sailors and shipwrights, and building ships for the Russian navy.

Potemkin also had a number of workshops at Krichev for making sailcloth, rope and other ships' fittings, as well as a distillery, a pottery and manufactories for working metal, wood and glass. Samuel was charged with their management, and recruited specialised craftsmen from Britain to direct the several operations. It has been said that Samuel's concern was with how these supervisors might best train and oversee a force of inexperienced local workmen. According to Simon Werrett however, he was in fact as much concerned with lack of discipline and application among the British craftsmen as among the peasant labourers.⁴ In both cases the answer seemed to lie in the architectural design of new factory buildings.

The first sources of information about Samuel's invention of the Panopticon principle are the letters written by Jeremy to various correspondents, including their father, while he was at Krichev in 1786-7.⁵ (Samuel also wrote down his ideas, but it seems those notes are lost. As he wrote to Jeremy in November 1787 after his brother had returned to Britain: 'Inspection house papers I have mislaid or by mistake sent to you'.)⁶ In December 1786 Jeremy wrote to his friend Charles Brown:

My Brother has hit upon a very singular new and I think important /
though simple / idea in Architecture which is the subject of a course of
letters I have just finished for my Father which it is not improbable may
find their way to the press [...] The architectural idea ~~consists in nothing~~
~~but~~ / in the plan of what we / call an Inspection-house is that of a circular
building so contrived that any number of persons may therein be kept in
such a situation as either to be, or what comes to nearly the same thing to
seem to themselves to be, constantly under the eye of a person or persons
occupying a station in the centre which we call the Inspector's Lodge. You

⁴ Simon Werrett, 'Potemkin and the Panopticon: Samuel Bentham and the Architecture of Absolutism in Eighteenth Century Russia', *Journal of Bentham Studies*, vol.2 (1999), <http://ojs.lib.ucl.ac.uk/index.php/jbs/article/view/10>, accessed 17 July 2012.

⁵ See *The Correspondence of Jeremy Bentham* (henceforth 'Correspondence'), vol. ix., ed. I.R. Christie, Oxford, 1971 (*The Collected Works of Jeremy Bentham*, henceforth 'CW'), iii.

⁶ *Ibid.*, p. 595, letter from Samuel to Jeremy Bentham, early November 1787.

will be surprised when you come to see the efficacy which this simple and seemingly obvious contrivance promises to be to the business of schools, manufactories, ~~Hospitals and all sorts of~~ Prisons, and even Hospitals, if one may venture to say so to an adept.⁷

The letters to his father, to which Jeremy refers, did indeed ‘find their way to the press’, together with some very substantial ‘postscripts’, as *Panopticon: or, the Inspection-House* (1791), and again in *The Works of Jeremy Bentham* (Vol. iv, 1843).⁸ This is where the application of the Panopticon concept to prison design was worked out in detail, and where the famous architectural scheme of 1791 was published. I will come back to this design.

In April 1787 Jeremy drafted another letter from Krichev in Samuel’s name, addressed to the prime minister William Pitt—but which was never sent—referring to ‘a particular kind of building contrived by me [Samuel] for the purposes of keeping persons of any description under the eye of an Inspector’.⁹ It seems that Jeremy had previously sent Pitt copies of the letters to his father. Now Samuel was intending to offer Pitt his services in the running of a national Panopticon penitentiary.

Given the respective characters of the two brothers, it makes sense that Samuel should have been the originator of the ‘inspection principle’. Jeremy was the philosopher and theoretician, scholarly and reclusive. Samuel was outgoing, friendly and persuasive, had studied engineering and the sciences, and above all was gifted with a fertile mechanical creativity.¹⁰ The list of his improvements, inventions and patents, most of them relating to the art of shipbuilding, runs to several pages.¹¹ In Russia he had impressed Potemkin with an ‘amphibious carriage’ convertible to a

⁷ *Ibid.*, pp. 501–3, letter from Jeremy to Charles Brown, 18/29 December 1786. Passages struck through are deleted in the manuscript. Passages between ‘/’ are inter-lineations.

⁸ Letters and Postscripts were published as *Panopticon: or, the Inspection-House*, Dublin, 1791, and *Panopticon: Postscript*, 2 vols., London, 1791. They were later republished in Bowring, iv., as ‘Panopticon; or the Inspection-House’, pp. 37–172, along with ‘Panopticon versus New South Wales: or the Panopticon Penitentiary System, and the Penal Colonization System, Compared’, pp. 173–211. Both Letters and Postscripts are included in *The Panopticon Writings*, ed. M. Bozovic, London and New York, 1995. The political history of the Panopticon and Bentham’s struggles to have it built are told by Janet Semple in *Bentham’s Prison: A Study of the Panopticon Penitentiary*, Oxford, 1993, Chapters 3 and 4.

⁹ *Correspondence (CW)*, iii. pp. 534–6, draft letter to William Pitt

¹⁰ For an attractive account of the private and family lives of the two brothers, and their contrasting characters, see C. Pease-Watkin, ‘Jeremy and Samuel Bentham: The Private and the Public’, *Journal of Bentham Studies*, vol. 5 (2002), <http://ojs.lib.ucl.ac.uk/index.php/jbs/article/view/22>, accessed 17 July 2012.

¹¹ Mary Sophia Bentham, ‘Memoir of the late Sir Samuel Bentham’ pp. 77–9.

boat, built partly with his own hands, in which he travelled the country by road and river.

While in Potemkin's employ he also devised a new kind of ship for navigating the sinuous and shallow waters of the Dnieper and its tributaries. Christened by the brothers the 'vermicular', this consisted of a number of separate barges linked by universal joints, so that the whole composite craft could bend like a worm to negotiate even the sharpest turns.¹² Samuel built several such boats to carry timber and the products of the Krichev manufactories including parts of battleships for the Crimean fleet; and Potemkin commissioned an Imperial vermicular, in which the Empress Catherine was to have toured the south of the country. This was over 250 feet long, had a draught of just six inches, contained splendid apartments and bedrooms for the Empress, and was crewed by 120 oarsmen under the direction of Samuel himself, who stood at the stern with a megaphone. One can perhaps see, in these Russian boats of Samuel's, something of the bold eccentricity that also characterised the Panopticon.

When war broke out in 1787 between Russia and the Ottoman Empire, Potemkin sold the estate, and plans for the new workshop had to be abandoned. Samuel was ordered south to the Crimea where he distinguished himself in several naval battles. His own contemporary Panopticon notes seem to have been lost, as we have seen. The letter from Jeremy to Charles Brown quoted above refers to the projected building as 'circular', and Jeremy's prison designs of 1787 and 1791 were buildings with circular and polygonal plans respectively. Later, after his return to England, Jeremy wrote:

The purpose to which this rotunda-form was destined to be employed by my brother, was that of a large workshop [...] partitions in the form and position of radii of the circle being employed in separating from each other such as required to be so separated; in the centre was the [...] Inspector's Lodge; from thence by turning around his axis, a functionary standing or sitting on the central point, had it in his power to commence and conclude a survey of the whole establishment in the twinkling of an eye.¹³

This would seem to imply that the building was perfectly circular (it had a 'rotunda-form'). On the other hand Samuel's widow Mary Sophia wrote in 1856: 'The

¹² Christie, *The Bentham's in Russia*, pp. 167–9

¹³ Bowring, xi, p. 97

[planned] building consisted of a centre from which diverged several long rays, all of them, on all the stories, capable of inspection from the central part'.¹⁴ It is reasonably clear that she is talking here about the Krichev factory since she gives its date as 1787. The reference to 'long rays' suggests something quite different from the brothers' two circular prison schemes.

Samuel Bentham's School of Arts in St Petersburg

As it turned out, Samuel got a second chance to realise his Panoptical workshop.¹⁵ In 1805 the Navy offered him the opportunity to return to Russia to build warships there for Britain, which he accepted. He negotiated an arrangement with the Russian Minister of Marine that for every British ship constructed he would produce another of similar design for Russia. Tsar Alexander however vetoed the use of timber for building foreign vessels: in an effort to please him, Samuel offered to construct a 'School of Arts' on the river Okhta in St Petersburg in which craftsmen and shipwrights were to be trained. The recruits were to work in the manufacture of equipment and supplies for the Russian navy including clothing, woodwork, sailcloth and navigational instruments. By September 1807 the building was nearing completion under Samuel's supervision; then the Tsar declared war on Britain and Samuel had to return home again.

Figure 1 shows a drawing of the school dating from 1810 held in the Russian State Naval Archive, giving a plan, an elevation and two sections. Figure 2 is my own cutaway bird's eye view, constructed from these Russian drawings and detailed descriptions given by Mary Sophia Bentham in *The Mechanics' Magazine* (1849) and *The Civil Engineer and Architect's Journal* (1853).¹⁶ Figure 3 reproduces a part-

¹⁴ Mary Sophia Bentham, 'Principal Inventions', p. 19. Mary Sophia talks here however of Jeremy visiting Samuel at 'Cherson' [Kherson], the port in the Crimea to which Samuel moved in late 1787

¹⁵ Mary Sophia Bentham, 'Memoir of the late Sir Samuel Bentham', pp. 65–6

¹⁶ Mary Sophia Bentham, 'On the Application of the Panopticon, or Central Inspection Principle to Manufactories and Schools', *The Mechanics' Magazine, Museum, Register, Journal, and Gazette*, vol. 50, (January-June 1849) pp. 295–7. Mary Sophia Bentham, 'The Panopticon or Inspection Principle in Dockyards and Manufactories', *The Civil Engineer and Architect's Journal*, vol. 16 (1853), pp.453–5. There is one further, very mysterious drawing in *The Mechanics' Magazine* article, besides those reproduced here. Mary Sophia says that this is a plan of the Okhta School, but at a different scale from the section. The plan has three rings that seem to be in about the same proportions as in the Russian drawings. But otherwise the details seem not to correspond in any respect. Could this be a roof plan? A structural layout? I have no plausible interpretation.

section from the *Mechanics' Magazine* article, which broadly matches one of the Russian sections, although there are several discrepancies.¹⁷

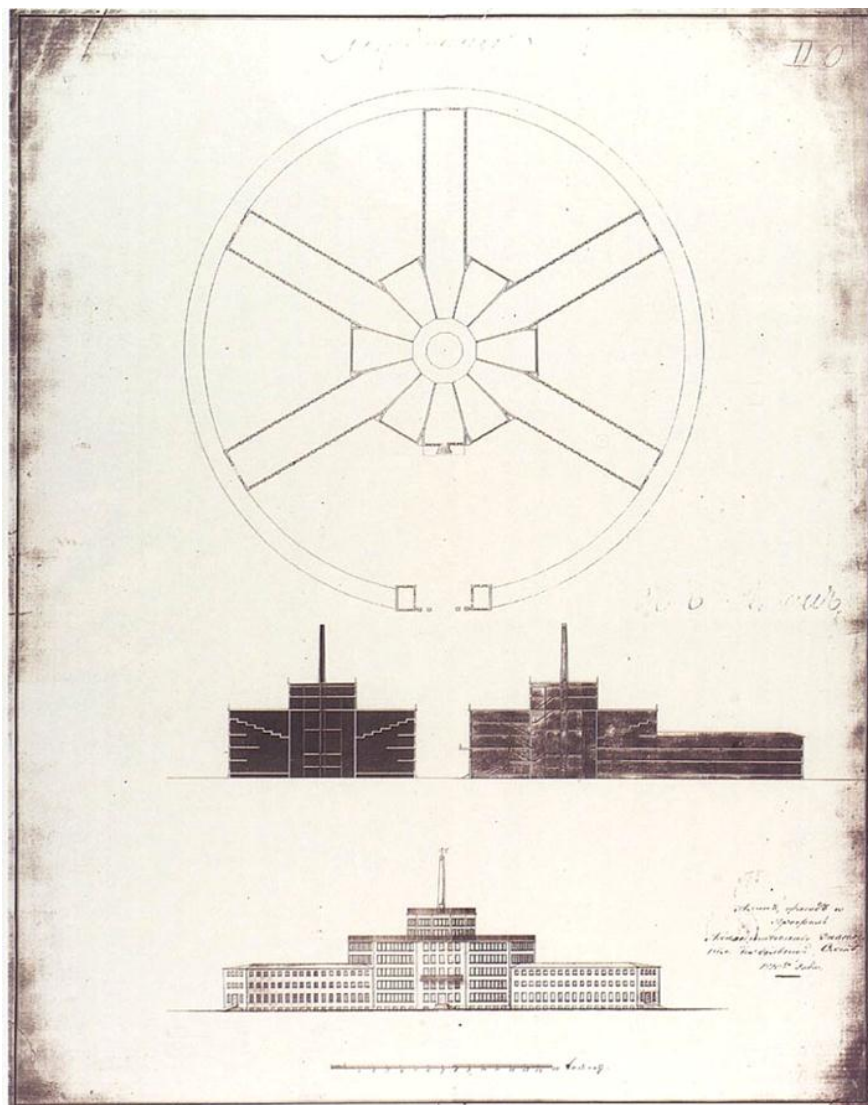

Figure 1: Samuel Bentham's School of Arts in Saint Petersburg, 1807: plan, elevation and two sections (Russian State Naval Archive).¹⁸

¹⁷ Mary Sophia's drawing has a structure on the roof of the central tallest rotunda that appears to contain a water tank. This does not appear in the Russian design. Her drawing shows no basement (although she mentions one). However a half-basement is evident above ground in the Russian elevation and sections, although the part below ground is not visible in the sections. The relative diameters of the various cylindrical parts are not the same in the two sources. In fact the whole issue of *scale* is problematic. The Russian drawing has a scale in which the unit appears to be the *sazhen* or Russian fathom (appropriate for a naval building). Peter the Great had decreed that the *sazhen* should equal 7 English feet. But applying this scale to the drawing of the School results in dimensions that seem too small: for example storey heights come out at around 6 feet 8 inches. Mary Sophia's drawing has no scale, although she gives various key dimensions of the building in her text. These cannot be reconciled exactly with the Russian drawing. I have nevertheless worked to the *sazhen* scale in my Figure 2; but I suspect that the School was actually somewhat larger than my own scale (in metres) would indicate.

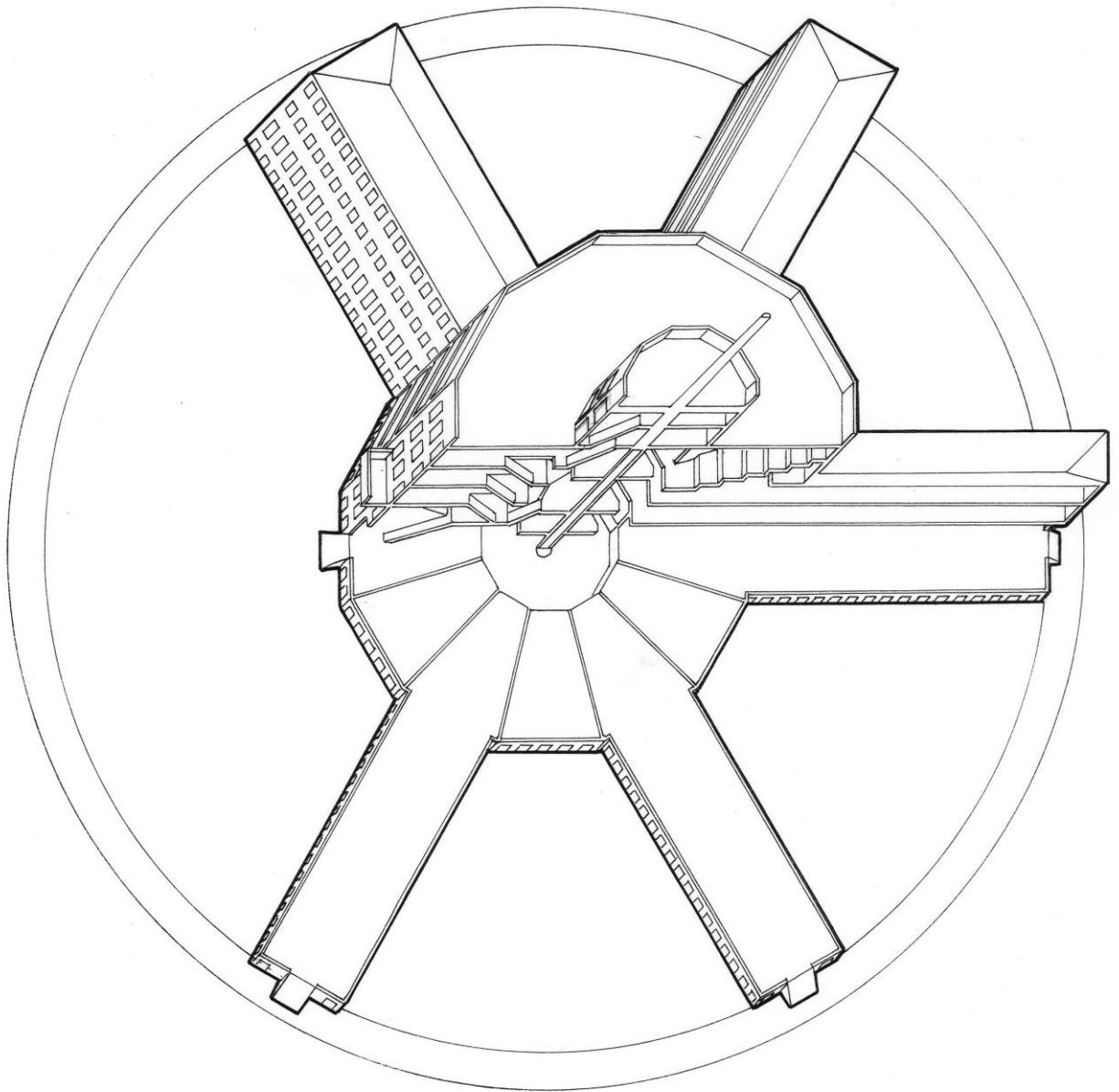

Figure 2: School of Arts in Saint Petersburg: cutaway bird's eye view (Author's drawing)

¹⁸ Rossiiskii Gosudarstvennyi Arkhiv Voenno-Morskogo Flota, St Petersburg, fond 326, opis' 1, delo 10043. The drawing is published on the website of the Bentham Project at University College London at www.ucl.ac.uk/Bentham-Project. Permission to reproduce the image was obtained by Professor Roger Bartlett of the School of Slavonic and East European Studies, UCL. The inscription reads 'Plan, façade and profile of the Panoptical Institution on the Great Okhta, 1810'.

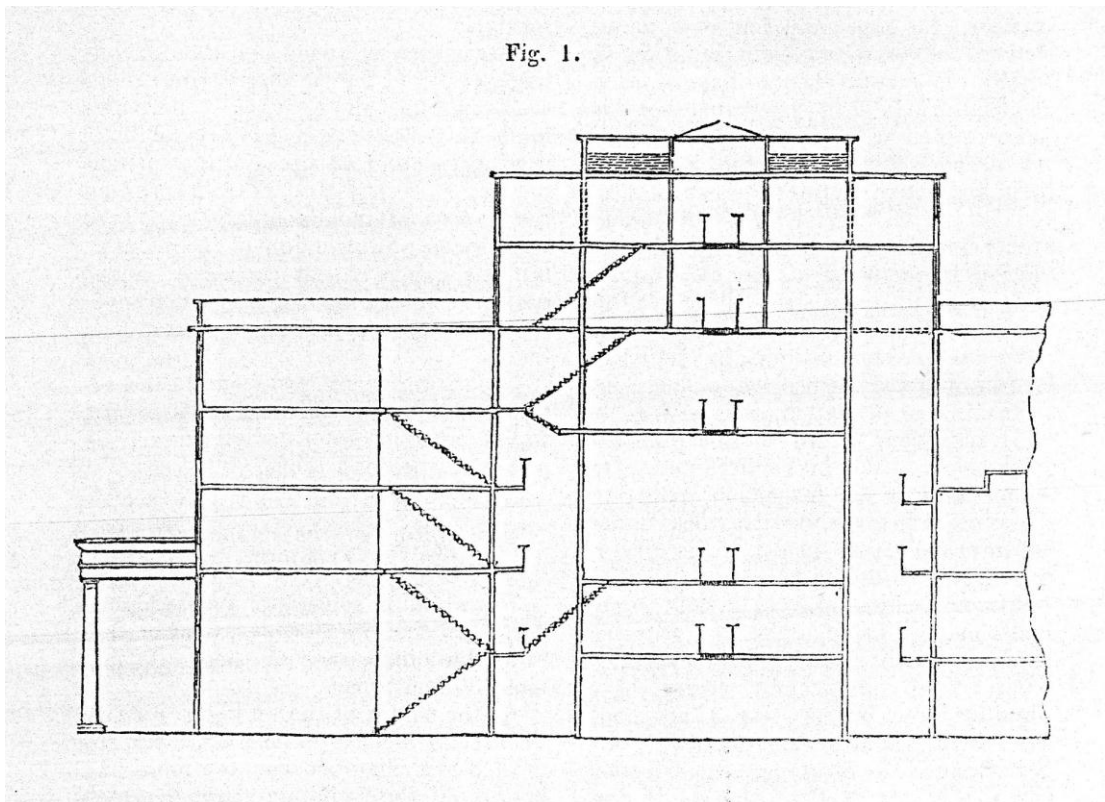
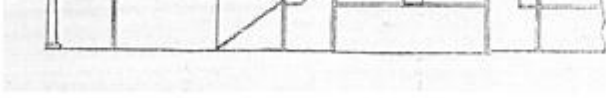

Figure 3: School of Arts in Saint Petersburg: part section.¹⁹

The flat roofs, plain regular fenestration and overall pyramidal form give the building a curiously Twentieth Century, even proto-Soviet aspect, despite its Imperial patron. It consists of a twelve-sided drum at the centre, roughly 28 m [90 feet] in diameter, with five radiating wings, each of them 21 m [70 feet] long and 6.5 m [20 feet] wide. (These approximate dimensions come from the Russian drawing and differ from measurements mentioned by Mary Sophia in her texts – see footnote.) A portico and main entrance take the place of the missing sixth arm. The wings are on three storeys and—since their interiors are wholly visible from the centre—they are presumably open plan.

The drum is made up in plan of three concentric rings. The central ring is 5.5 m [18 feet] in diameter, on six storeys, plus a basement that according to Mary Sophia contained heating plant and the water supply. The ground floor contains an office for clerks. Above this is the ‘principal inspection room’. ‘Occasional inspection’ is also

¹⁹ *Mechanics Magazine*, vol. 50 (1849), p. 296, fig. 1.

possible from the next two floors. All three of these floors are in effect floating circular platforms. The topmost two floors serve as an infirmary that is separated from the remainder of the building.

Around all these rooms is an annular space, 2 m [6 feet 6 inches] wide, which rises as a void through the five main storeys. It is surrounded by galleries, and crossed by stairs to the observation platforms. The third and outermost ring, 9 m [30 feet] wide, is divided into twelve wedge-shaped spaces, five of which form parts of the radiating wings. There are four storeys in this part, the topmost having a stepped floor – although in the part immediately above the entrance all the floors are flat. We might guess that most of the spaces on this level are auditoria of some kind. (None of the drawings is labelled with room functions.)

We can compare the design of this central drum with two other projects on the inspection principle that Samuel had worked on previously back in England, neither of which was built. Mary Sophia describes the first of these in the *Mechanics' Magazine* article. This was a school for 'gentlemen cadets' at Woolwich, designed by Samuel in the 1790s.²⁰ Mary Sophia includes a plan (Figure 4). A friend of Samuel's, Colonel Twiss, had asked him to prepare the scheme, which was then worked up by the architect Samuel Bunce.²¹ The building is semicircular and divided into four radial parts. Three of the spaces are lecture rooms: each has 'Desks for the Cadets' and a 'Desk for the Master' at the narrow end of the room. The fourth space is left clear for 'fencing and dancing'. At the very centre is a small room with glass walls from which the Lieutenant Governor and Inspector can watch both masters and pupils at work. We can imagine that Samuel had essentially the same arrangement in mind for the top-floor classrooms at Okhta—assuming that is indeed their purpose—although these would have had tiered seating, rather than what were evidently flat floors (think of the dancing) at Woolwich. Also, going by the Russian drawing, the Okhta School would have had at least seven and perhaps nine classrooms.

²⁰ Mary Sophia Bentham, 'Manufactories and Schools', p. 298

²¹ Bunce worked as an architect for the Navy Department.

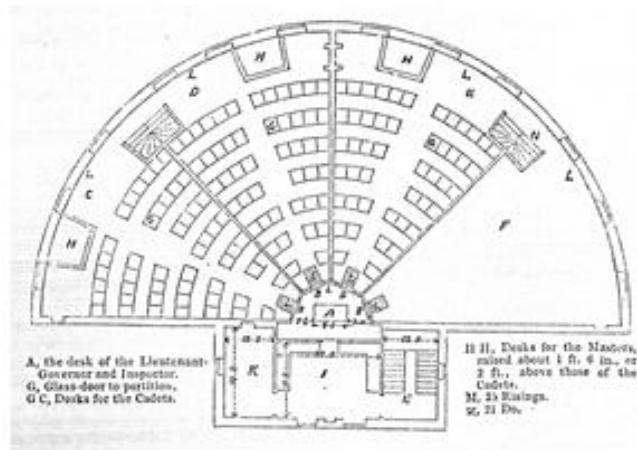

Figure 4: Samuel Bentham with Samuel Bunce, project for a school for naval cadets at Woolwich, 1790s: plan.²²

In 1797 Samuel had collaborated with Bunce on a second Panoptical scheme: a standard design for a workhouse for paupers or House of Industry.²³ They proposed that 250 of these be built across Britain, each housing 2000 inmates. Figure 5 shows a plan, section and elevation. The building's form is that of a twelve-sided drum on five storeys, divided internally into concentric rings, with inspection from central platforms and a void rising between these platforms and the outer ring of wedge-shaped rooms. Comparison of the respective sections shows that the form and arrangement of this House of Industry are almost identical to those of the main drum of the Okhta School, the only substantive difference being that the House of Industry lacks the infirmary on top. Inspection is from intermediate level floors in both cases, and the House of Industry even has some top-floor auditoria or classrooms with stepped floors. One should also notice the close similarities in the fenestration of the two buildings, in continuous strips of windows with narrow iron frames. Robin Evans

²² *Mechanics Magazine*, vol. 50 (1849), p. 296, fig. 3.

²³ Jeremy Bentham, 'Outline of a Work Entitled Pauper Management Improved', published in *Annals of Agriculture* in 1797, and reprinted in Bowring, viii. pp. 369–439. The drawings of Figure 5 appear here facing p. 374.

was particularly struck by the modernity of these facades, saying ‘Nothing quite like [them] would be seen again until the middle of the next century’, and citing in comparison G T Greene’s Naval Dockyard Boat Store at Sheerness of 1858-61.²⁴

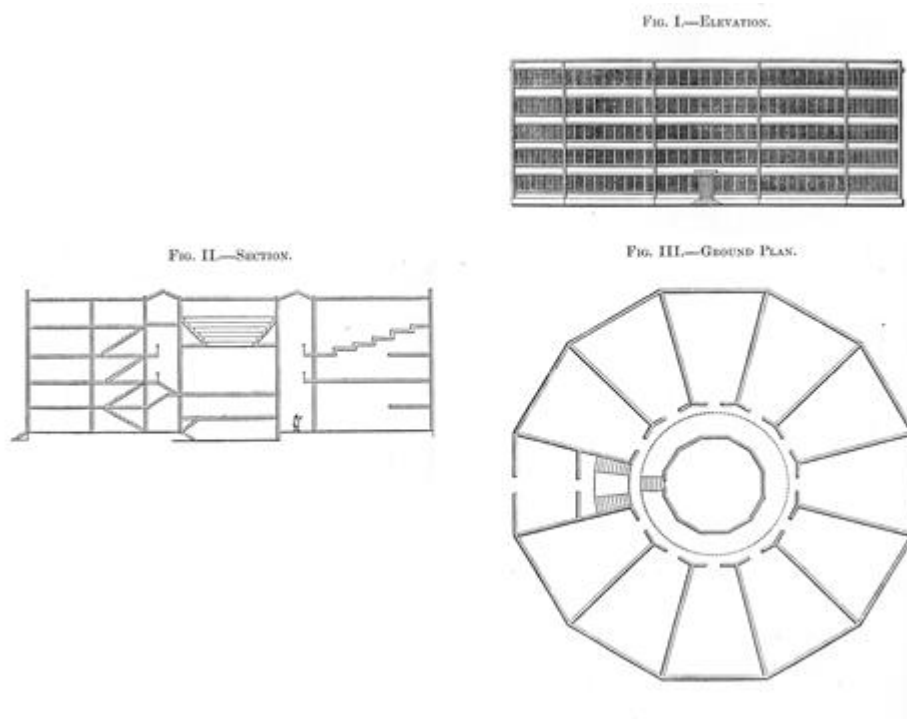

Figure 5: Samuel Bentham with Samuel Bunce, project for a House of Industry, 1797: plan, section and elevation.²⁵

Supervision in the School of Arts

The key purpose of the geometry of the whole structure at Okhta is of course supervision of all the cadets, apprentices and their teachers working in the different spaces. The audiences in what I have suggested are raked lecture theatres are overseen by their instructors and from the centre. The students occupied in the radial workshops can all be observed from the ‘principal inspection room’ and from the platform on the floor above: notice in the Russian drawing how these floors at the centre are staggered in section in relation to the floors in the wings, so that two storeys in the wings are visible from each of the inspection platforms. Mary Sophia—

²⁴ R. Evans, *The Fabrication of Virtue. English Prison Architecture, 1750-1840*, Cambridge, 1982, p. 222, and n. 78 p. 440. Evans says (p. 440): ‘It is tempting to suggest a connection, particularly as Samuel Bentham was a very active Inspector General of Naval Works between 1796 and 1805, and later (1812) designed a dock complex for Sheerness’.

²⁵ Bowring, viii., plate facing p. 374.

who accompanied Samuel on this Russian trip—describes how she was allowed to enter the building when it was nearly finished: ‘From the central chamber a perfect view was obtained of all that passed within the walls on each of two floors, the rays inclusively’.²⁶ Inspection ‘was effected by a very nice adjustment of the relative height of floors—one of the two principal floors being *below*, the other *above* the floor of the inspection room’.²⁷

At the very centre we find the building’s most extraordinary feature. Here is a narrow cylindrical space, about 1 metre in diameter, extending the full height of the building up to the level of the infirmary. Inside the cylinder is a chair for the Inspector of the School, ‘...suspended by a counterpoise, and regulated in its movements up and down by a simple and safe apparatus, easily managed by the inspector himself’.²⁸ By pulling on the ropes, the Inspector can propel himself vertically, to arrive unexpectedly at the different levels including the focus of all the classrooms on the top floor, and check that everybody is hard at work.

According to Mary Sophia—not perhaps an entirely unbiased witness—the pupils trained in the School were ‘found so useful, that the best of these youth were taken for service elsewhere by fifty at a time, even as early as 1808’.²⁹ (How much this success was due to the architectural design is of course a matter for debate.) However the building did not survive for long. Samuel had specified that iron be used for the structural columns, but wood was substituted; and in 1818 the School caught fire and was destroyed.

The School of Arts in the historical literature

Since Mary Sophia’s articles in the 1840s and 50s and her biography of Samuel of 1862, the School of Arts has been largely forgotten, and is hardly touched on in the modern literature of the brothers’ Panopticon designs and the prisons they inspired. No doubt this neglect is due in part to the short life of the Russian building, the fact that it was a school not a penal institution, and the fact that it was geographically

²⁶ Mary Sophia Bentham, ‘Dockyards and Manufactories’, p. 454

²⁷ Mary Sophia Bentham, ‘Manufactories and Schools’, p. 297

²⁸ *Ibid.*, p. 297. This space is just visible in the Russian cross-sections. The flying chair was not however in operation by the time the Benthams had to leave Russia.

²⁹ *Ibid.*, p. 297

remote from developments in Europe. Also the Russian drawing of Figure 1 has only relatively recently been published in the West.

Janet Semple mentions the St Petersburg School briefly in her 1993 monograph on *Bentham's Prison*, but gives no description of its architecture.³⁰ Ian Christie's *The Bentham's in Russia* only covers the period up to 1791. Simon Werrett in a fascinating paper on 'Potemkin and the Panopticon' gives due credit to Samuel for inventing the inspection principle, and argues for fuller consideration of the local political and cultural context of the Krichev workshop.³¹ This, he says, would have essentially compressed the spatial structure of the Russian estate into a single building, with the noble at the centre and his peasant labourers surrounding him. There would have been further echoes, Werrett suggests, of the centralised architecture of the typical Russian Orthodox church, both buildings privileging visibility and emphasising the omnipresence of God and the Inspector respectively. Werrett touches briefly on the St Petersburg School of Arts; but he does not elaborate on its form or geometrical modes of oversight. What he does reveal is that the building *did* have some local influence: 'Soon after its construction, the Tsar was building Panopticons across Russia, as the Okhta School of Arts was "copied in several other private as well as Government establishments in that Empire"'.³²

Robin Evans mentions the School of Arts only fleetingly, and not even by name, in his 1971 paper on the brothers' Panopticons of 1787 and 1791.³³ In his influential book on English prison architecture, *The Fabrication of Virtue* (1982), Evans again gives the briefest of descriptions, saying that the school had 'radiating wings on a central hub'. He pairs it with a later unbuilt scheme for a naval arsenal at Sheerness that Samuel presented to the Admiralty in 1812 (Figure 6).³⁴ At the centre of this dockyard site is a building with a twelve-sided central part and five radiating wings, very similar in plan to the Okhta School. The dimensions are nearly the same. Clearly Samuel has essentially repeated the Russian design. The centre contains offices, and stores and workshops occupy the wings.

³⁰ Semple, *Bentham's Prison*, pp. 214–5

³¹ Werrett, 'Potemkin and the Panopticon'.

³² *Ibid.*, note 69, *Correspondence (CW)*, viii. p. 224, Werrett also cites a letter from Admiral Chichagov to Samuel Bentham, September 17th 1807; British Library Add. MSS. 33544 folio 316.

³³ R. Evans, 'Bentham's Panopticon: An Incident in the Social History of Architecture', *Architectural Association Quarterly*, vol. 3 (April/ July 1971), pp. 21-37. See p. 33: 'No Panopticon building was ever erected by Jeremy and only one, "fleetingly", under the direction of Samuel'.

³⁴ Evans, *Fabrication of Virtue*, chapter 5. The Sheerness scheme is also illustrated by Mary Sophia Bentham in 'Dockyards and Manufactories', p. 453

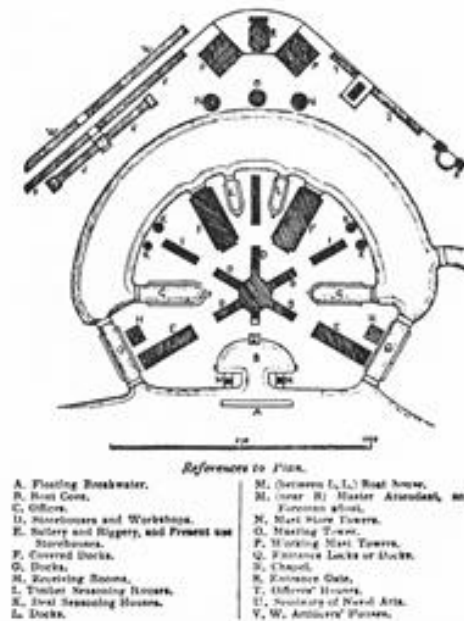

Figure 6: Samuel Bentham, project for a naval arsenal at Sheerness, 1812: plan.³⁵

We might guess that the internal room layouts of the two buildings would have been somewhat different however, since the Sheerness structure was not a school, and the officers were to watch over activities outside as well as inside the building. In a letter accompanying the plans Samuel emphasises the Panoptical virtues of the general arrangement of the site, and how ‘the officers being all of them in the centre of the central building, and a higher part of that centre having a commanding view of the whole dockyard, every work, every transaction on the dockyard, may be inspected in different degrees of perfection from that central situation’.³⁶

There is no reference to Okhta in Norman Johnston’s wide-ranging international history of prison architecture *Forms of Constraint*, although he does cite Jeremy’s account of the projected Krichev factory, quoted earlier.³⁷ On this basis he describes that building as a ‘circular two-story textile mill, about one hundred feet in diameter’.

³⁵ *Civil Engineer and Architect’s Journal*, vol. 16 (1853), p. 453

³⁶ Letter from Samuel Bentham to Bernal Osborne MP, Secretary of the Admiralty, quoted by Mary Sophia Bentham in ‘Dockyards and Manufactories’, p. 453

³⁷ (See note 13 above.) N. Johnston, *Forms of Constraint: A History of Prison Architecture*, Urbana and Chicago, 2000, p. 50 and n. 33

On the other hand he says in a footnote: ‘This building is sometimes described [presumably by Mary Sophia, although Johnston does not say] as though there were two-story wing buildings radiating from a central rotunda.’ This he adds is ‘unlikely’.

Failure of the Panopticon penitentiary

Applying the Panopticon principle to prison design posed a fundamental dilemma: the cells needed to be open for observation, but closed in order to keep the prisoners secure. The solution proposed by Jeremy in the letters and postscripts was to have cells with barred fronts: these would necessarily have to be arranged in an arc of a circle or in a full circle around the ‘inspector’s lodge’ so that he could see into every part of all of them. Should more cells be required, these could be in circles on floors above.

Figure 7 shows the first scheme for a Panopticon penitentiary on which the two brothers worked together during 1787, and which was published with the letters.³⁸ The building is cylindrical, on four floors, with a ring of narrow single-person cells around the periphery and rooms for the governor and his staff at the centre. The floors in these observation rooms are on half levels relative to the cells, so that two floors of cells can be overseen from each observation floor – as at the Okhta School. Every cell has a large window, so that seen from the centre it is backlit and the prisoner’s every movement is clearly visible. In Michel Foucault’s words, the cells ‘are like so many cages, so many small theatres, in which each actor is alone, perfectly individualised and constantly visible’.³⁹

³⁸ An engraver at the printers improvised this drawing, since the original was thought to have been lost in a fire. It appears as Plate 1 in *Panopticon*. Presumably the original was produced by the brothers at Krichev.

³⁹ M. Foucault, *Surveiller et Punir: Naissance de la Prison*, Paris, 1975, transl. by A. Sheridan as *Discipline and Punish: The Birth of the Prison*, London, 1977, p. 200

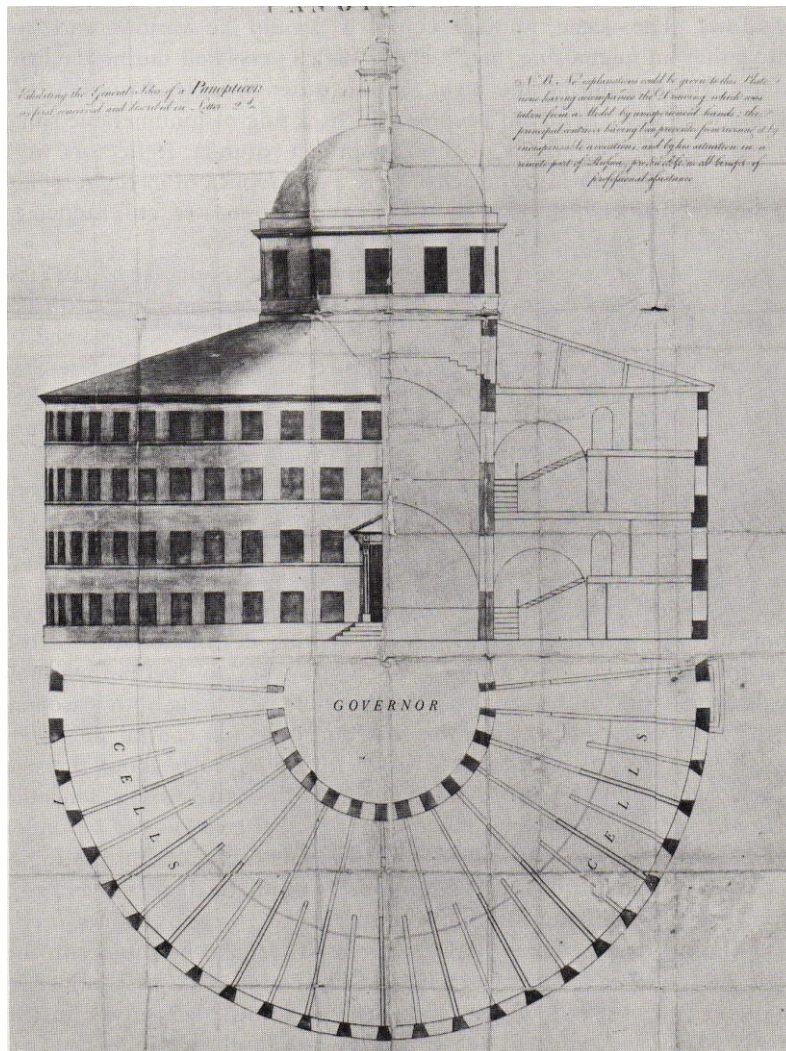

Figure 7: Jeremy and Samuel Bentham, design for Panopticon penitentiary, 1787: half-plan, half-section and half-elevation.⁴⁰

Jeremy was much concerned however that this process of observation be *one-way*: he wanted the governor and the warders and visitors to the prison to be able to watch the prisoners, but he did not want the prisoners to watch back. In this way they would be under the constant apprehension of being observed, even if no one was actually looking at that moment in their direction. So he proposed that the central observation rooms be curtained, with peepholes cut—the size of ‘silver spangles’—through which the guards could look out. But this meant that the centre would have been in more or less complete darkness. What is more, Jeremy realised it seems that there was insufficient space in the middle of the building to house all the other

⁴⁰ Jeremy Bentham, *Management of the Poor*, Dublin, 1796, plate 1.

functions needed in a prison: lodgings for the doctor and chaplain, the kitchen, stores and so on.

Figure 8 shows the revised scheme drawn up by Jeremy and Samuel in 1791 with the help of the architect Willey Reveley designed to overcome some of these difficulties. (Jeremy had met Reveley in Smyrna on his journey to Russia).⁴¹ Now there are larger cells on six storeys. As well as windows, the building is lit from the top with an annular roof-light and a central oculus (Figure 9). The governor's house and offices have been removed from the middle to a rectangular block attached to the outside of the building, which Jeremy refers to rather oddly as 'the dead part'. Services are in the basement.

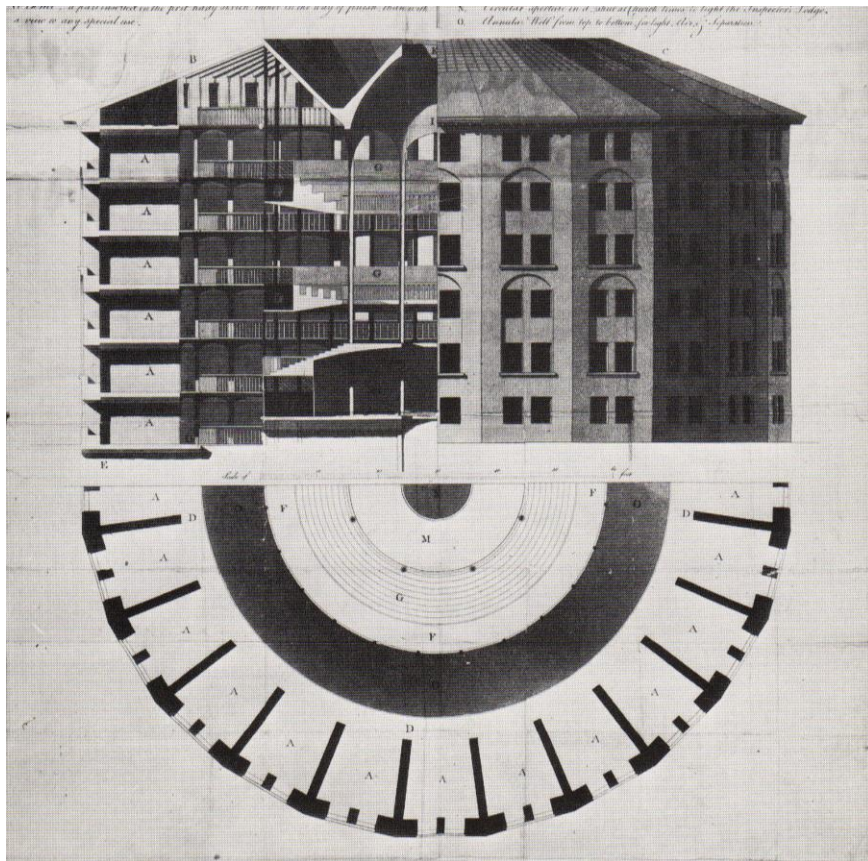

Figure 8: Jeremy and Samuel Bentham with Willey Reveley, design for Panopticon penitentiary, 1791: half-plan, half-section and half-elevation.⁴²

⁴¹ Christie, *Benthams in Russia*, p. 150

⁴² Bentham, *Postscript*, plate 2 (following p. 172).

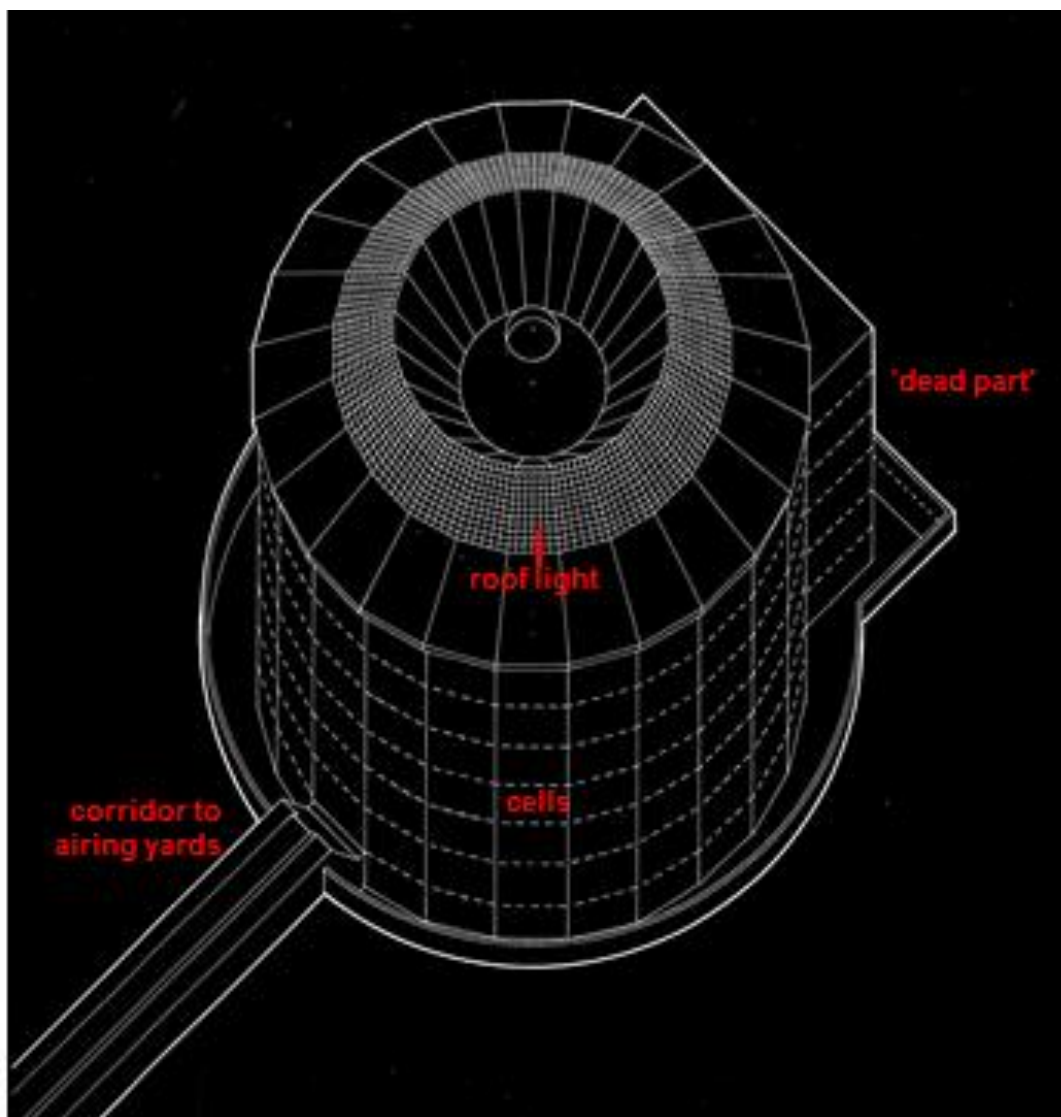

Figure 9: Bird's eye view of the 1791 Panopticon penitentiary (Author's drawing)

Observation is now on three levels, but no longer from central positions: instead there are three 'annular galleries' around which the guards circulate. Figure 10 shows a section. The lowest gallery surrounds the 'inspector's lodge', and the other two are supported on columns above. As in the 1787 scheme the galleries are on half-levels so that two floors of cells are overseen from each gallery. The galleries are again to be curtained, with the warders looking out through spyholes. Inside the annular galleries is raked seating for visitors attending divine worship. The plan was for the prisoners to attend the services from their cells – although not all of them would have been able to see the chaplain.

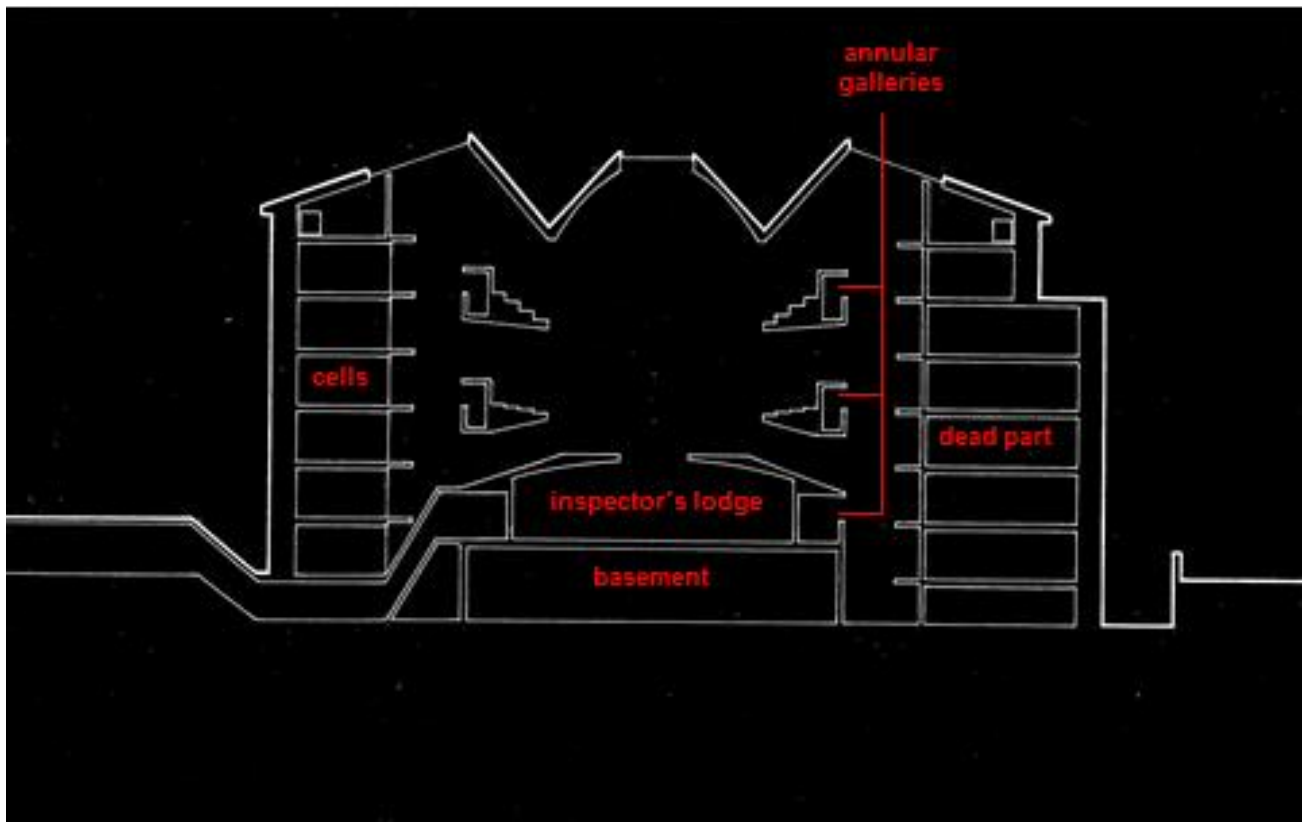

Figure 10: Section of the 1791 Panopticon penitentiary (Author's drawing)

I have written elsewhere about the contradictions inherent in this 1791 scheme as an operating prison.⁴³ There are four major problems. The first is that the convicts completely surround the guards – never a good idea in penal design. Should they manage to seize the two entrances, they have all the staff trapped. (It should be said that this problem would not arise in semi-cylindrical buildings like a few of the Panopticon prisons that were actually built.)⁴⁴

Second, the goal of inspection from a single central point—the very essence of the Panopticon principle—is now seriously prejudiced by the annular galleries and the chapel, which get in the way of clear views across the centre of the building. The

⁴³ Philip Steadman, 'The contradictions of Jeremy Bentham's Panopticon penitentiary', *Journal of Bentham Studies*, vol. 9 (2007), <http://ojs.lib.ucl.ac.uk/index.php/jbs/article/view/48>, accessed 17 July 2012.

⁴⁴ Including Robert Adam's Edinburgh Bridewell of 1791-5, and J M Gandy's female wing at Lancaster Castle Gaol of 1818-21

guards might be able to see the cells in turn as they patrol around the rings; but no one at a higher level of responsibility can see all the guards, who have to report back if they spot trouble. Some later prisons that otherwise stuck closely to Jeremy's published designs did in fact leave the centres of their rotundas completely empty. This was the case in the three 'cupola prisons' built in Holland by J. F. Metzelaar and his son in the late Nineteenth Century, and at Stateville Penitentiary near Joliet, Illinois designed by W. Carby's Zimmerman and constructed between 1916 and 1924.⁴⁵ Eight rotundas were projected at Stateville, of which four were completed (Figure 11). Each had a central glazed guard-post and nothing else. But this of course entailed a great volume of unused space – what the American prison architect Alfred Hopkins described as 'the most awful receptacle of gloom ever devised'.⁴⁶



Figure 11: Interior of a cell block at the Stateville Penitentiary near Joliet, Illinois, U S A, W. Carby's Zimmerman architects, 1916-24 (Illinois Department of Corrections)

⁴⁵ See Johnston, *Forms of Constraint* p. 108 for the Dutch prisons, and pp. 143–44 for Stateville. The Dutch cupola prisons however had solid doors on the cells (like the radial prisons – see below) and so were not strictly Panopticons in the Bentham sense. In 2010 I met a male nurse working in the Dutch prison service who told me that he had played football with prisoners in the centre of the Breda Panopticon. So in a more relaxed regime the empty space found a use after all.

⁴⁶ A. Hopkins, *Prisons and Prison Building*, New York, 1930, p. 43.

One might add, in parenthesis, that Jeremy was not himself entirely happy with the annular galleries, which were Reveley's idea. He continued to sketch ideas in his notebooks for an hourglass-shaped 'inspection lantern', covered in translucent material. A single observer would be suspended in this lantern in the centre of the prison, which would presumably be cleared of all other structures, as at Stateville. (Exactly how the inspector would get in and out of the lantern without being seen, and how he would communicate with fellow officers, is not explained.) Samuel's 'flying chair' at Okhta was a perhaps more practicable if equally surprising implementation of essentially the same idea.

Third, if the fronts of the cells are barred and the prisoners can see out, Jeremy's desire for 'one-way vision' is enormously difficult to achieve. The warders may be hidden behind the screens or curtains as they patrol and watch; but once they come out of their hiding places the prisoners can see them coming. To get to a trouble spot in the 1791 building, a guard has to emerge from his gallery, run to a staircase, go up or down to a bridge across to the balcony outside the cells, and run round to the cell in question, all in full view. No inmate can be surprised in any wrongdoing. One former Stateville inmate, Paul Warren, gave a colourful description of the problem. 'They figured they were smart building them that way. They figured they could watch every inmate in the house with only one screw in the tower. What they didn't figure is that the cons know all the time where the screw is'.⁴⁷

Lastly, the very circularity of the Panopticon, together with the fact that the cell-fronts are barred, makes it easy for the prisoners to communicate with each other. Jeremy was convinced by his friend the great prison reformer John Howard to abandon his original 1787 idea of solitary confinement, and the larger 1791 cells are planned for three or four occupants, who obviously could talk among themselves. But he wanted absolutely to prevent all other communication. However if all the inmates come to the fronts of their cells, each can shout or signal to the occupants of a dozen neighbouring cells. They have better views than the guards do! What is more, a prisoner on one side of the building has a view either over or under the annular gallery to cells on the opposite side.

⁴⁷ P. Warren, *Next Time is for Life*, New York, 1953, p 139.

Success of the radial prison

All four problems were solved in the generic design of the Nineteenth Century radial prison, of which John Haviland's Eastern State Penitentiary in Philadelphia of 1822–36, and the 'model prison' at Pentonville in North London of 1840–42, were the earliest.⁴⁸ The military engineer Joshua Jebb is usually named as the designer of Pentonville, and he certainly directed the construction and was responsible for the building's sophisticated servicing systems. But there is a good case for giving Haviland at least some joint credit for the overall layout.⁴⁹ There were smaller radial prisons built in Britain in the late Eighteenth and early Nineteenth centuries, but the Eastern State and Pentonville were on a much grander scale and had enormous influence internationally. By the mid-Twentieth Century some 300 radial prisons had been constructed worldwide on their basic model.

I will concentrate here on Pentonville, which is still in operation as a prison. Figure 12 shows a bird's eye view. The building is entered through a *porte cochere* and a small front courtyard. The governor and chaplain's houses flank the entrance. From the court one passes into a central block with offices on the lower floors and the chapel above. At the very centre is a full-height space from which the four cell blocks radiate out. (Other prisons of the type have different numbers of wings.) These cell blocks have central top-lit halls rising to the roof, with the cells on either side accessed by balconies. The central observatory at Pentonville originally had a series of glazed structures like bay windows (they no longer exist) from which all the halls and balconies could be observed (Figure 13). Every cell door could be seen, although in some cases quite obliquely. In Henry Mayhew and John Binny's description, this panorama at Pentonville was like 'a bunch of Burlington Arcades, that had been fitted up in the style of the opera box lobbies with an infinity of little doors'.⁵⁰

⁴⁸ For the Eastern State Penitentiary see N. Johnston, with K. Finkel and J.A. Cohen, *Eastern State Penitentiary: Crucible of Good Intentions*, Philadelphia, 1994. For Pentonville see Evans, *Fabrication of Virtue*, pp. 346–387.

⁴⁹ Pentonville closely resembles Haviland's prison at Trenton, New Jersey of 1833–36. Norman Johnston says that Haviland supplied Jebb and the British Government with plans that were '...substantially those of the Trenton prison'. See 'John Haviland, 1792 – 1852', Chapter 6, *Pioneers in Criminology*, ed. H. Mannheim, Montclair, New Jersey, 1971.

⁵⁰ H. Mayhew and J. Binny, *The Criminal Prisons of London*, London, 1862, p. 120.

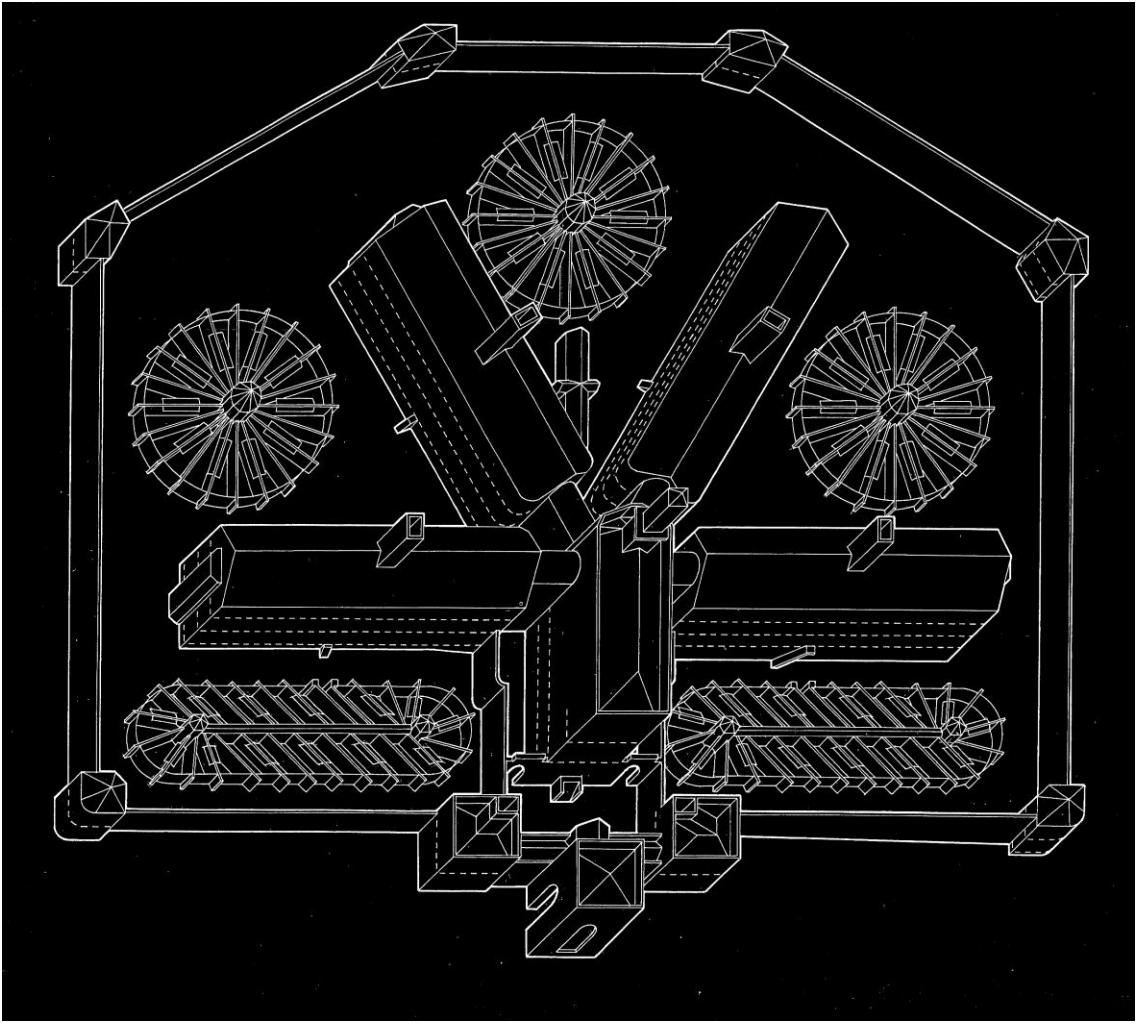

Figure 12: Bird's eye view of Pentonville Model Prison, London, Joshua Jebb engineer, 1840-2 (Author's drawing)

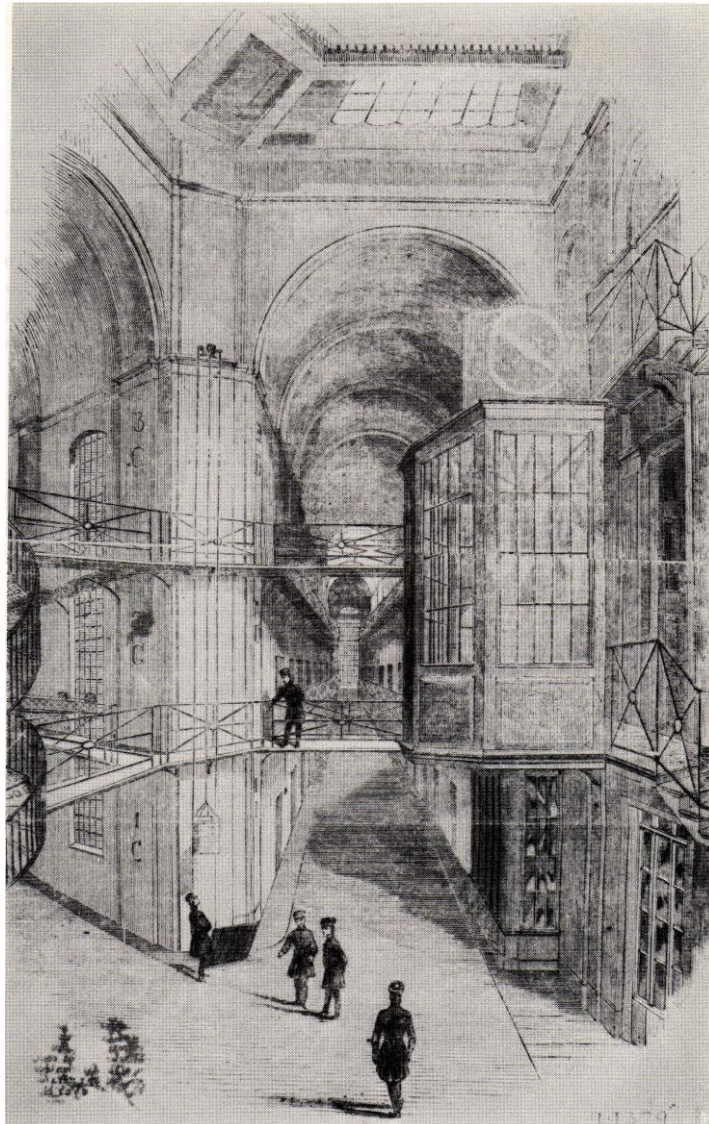

Figure 13: Pentonville Model Prison, London: the central observatory, giving views down all of the cell blocks (Evans, *Fabrication of Virtue*, p. 353, Figure 186)

The strange wheel-like and racetrack-like structures in the prison grounds (see Figure 12) deserve a passing mention. These are single-person exercise yards to which prisoners were taken one-by-one in the early years at Pentonville when the inmates were held in solitary confinement. The wheels have guards at the centres; the racetracks have guards patrolling the central corridors. These are indeed true Panopticons. (Soon they were abolished however in favour of exercise taken in groups.)

Pentonville and other similar radial prisons with their fan-like plans avoid the first difficulty of Jeremy's Panopticon, that the prisoners surround the guards. Now the prison's control centre is drawn to the front of the building and cannot be so easily

captured in a riot.

However the really key difference from the Panopticon is that the fronts of the cells are no longer barred but are closed off. Jeremy's principle of continuous inspection of the interiors of cells has been sacrificed, and the spyholes have migrated from the Panopticon's inspector's lodge and galleries to the doors of the Pentonville cells. The prisoners now have no views out of their cells. They cannot (or cannot easily) communicate with prisoners in neighbouring cells or cells opposite. Meanwhile the guards can approach right up to the cell doors without being observed by the inmates, and can look suddenly through the peepholes to surprise them in any wrongdoing. The prisoners are under the constant apprehension that this may happen. The radial prison effectively achieves Jeremy's goal of one-way vision.

It is the patrolling warders not the prisoners themselves who are now watched from the central observatory. There is a *two-level* system of oversight. Should the guards look into the cells and find trouble, or should trouble occur while prisoners are being moved to and from their cells, then the guards can summon reinforcements from the centre. (Interestingly, in these days of walkie-talkies and CCTV, the same system survives in Pentonville today. Help is still called by shouting or blowing whistles.) Those in the observatory can also oversee parts of the grounds of the prison through windows between the cell blocks – something which is not possible in Jeremy's Panopticon.

Furthermore by dropping the goal of watching the interiors of the cells at all times, the logic that obliged the Panopticon to be circular no longer applies. The great waste of open space at the centre of a Panopticon like Stateville can be collapsed into the narrow halls of the radial prison's rectangular cell blocks. These are the reasons I would suggest for the success of the radial prison, at least in numerical terms, and the fact that by contrast barely a dozen truly Panoptical prisons have been built in the last two centuries. At Stateville as mentioned only four of a projected eight rotundas were finished, and of those, three were soon demolished as unusable, to be replaced by long straight cell blocks.

Did the 'School of Arts' anticipate the radial prison?

The question remains: to what extent did Samuel's School at Okhta anticipate the design of the radial prison? In terms of overall form, with its five wings overseen

from the central observatory, the answer is clearly yes. On the other hand since it was a school not a prison, the requirements for oversight would have been rather less demanding. The wings at Okhta were open plan, while the wings at Pentonville are of course lined with closed cells. What is more the Okhta wings were on several floor levels and did not have full-height halls, so it was not possible to survey the entire building from one position. Nevertheless the pattern of oversight of the Okhta wings and the Pentonville halls *was* broadly similar. All the cadets and their instructors could be watched at Okhta without a large waste of unused central space as in the circular Panopticon. On each floor there was one point at the very centre from which the Inspector could see everyone—as Jeremy wanted and as was achieved in the collective (non-cell) spaces of Pentonville and the prisons that followed—and the Inspector could move rapidly between different floors on his flying chair. The School of Arts also had a fan-shaped plan like those of the radial prisons, although security obviously did not have the same priority in the two cases.

Those later circular prisons that corresponded most closely to the Panopticon penitentiary schemes of 1787 and 1791 were built in the late Nineteenth and early Twentieth centuries. However what has been described as the ‘*première réalisation panoptique européenne*’, La Tour Maitresse in Geneva took its first inmates in 1825 and was thus contemporary with Haviland’s Eastern State, and predated Pentonville. The architect was Samuel Vaucher-Crémieux.⁵¹ Jeremy Bentham had close links at this period with liberal Calvinists in Geneva: indeed it was a Genevan pastor Etienne Dumont who, having met Jeremy in 1788, became his most enthusiastic disciple and promoter. Dumont went on to edit, rewrite, rearrange, translate and publish Jeremy’s manuscripts; and so it was that many of the principal works on moral philosophy and legislative reform appeared first in French, only much later in English.⁵²

Dumont had a particular interest in prison reform, and acted as a personal link between Jeremy and those responsible for the design and regime of the Tour Maitresse. When we look at the prison’s plan however (Figure 14) we find not a drum-shaped building, but a semi-circular observatory with two radiating wings. These wings had open-plan workrooms on the ground floor and cells on the upper floor, whose doors only were visible from the centre. Can we detect the hand of

⁵¹ R. Roth, *Pratiques Pénitentiaires et Théorie Sociale. L’Exemple de la Prison de Genève (1825-1862)*, Geneva, 1981. Plans of the prison appear on p. 292

⁵² See C. Blamires, *The French Revolution and the Creation of Benthamism*, Basingstoke, 2008.

Samuel hovering over this building? There is certainly an affinity here with the Okhta School of Arts.

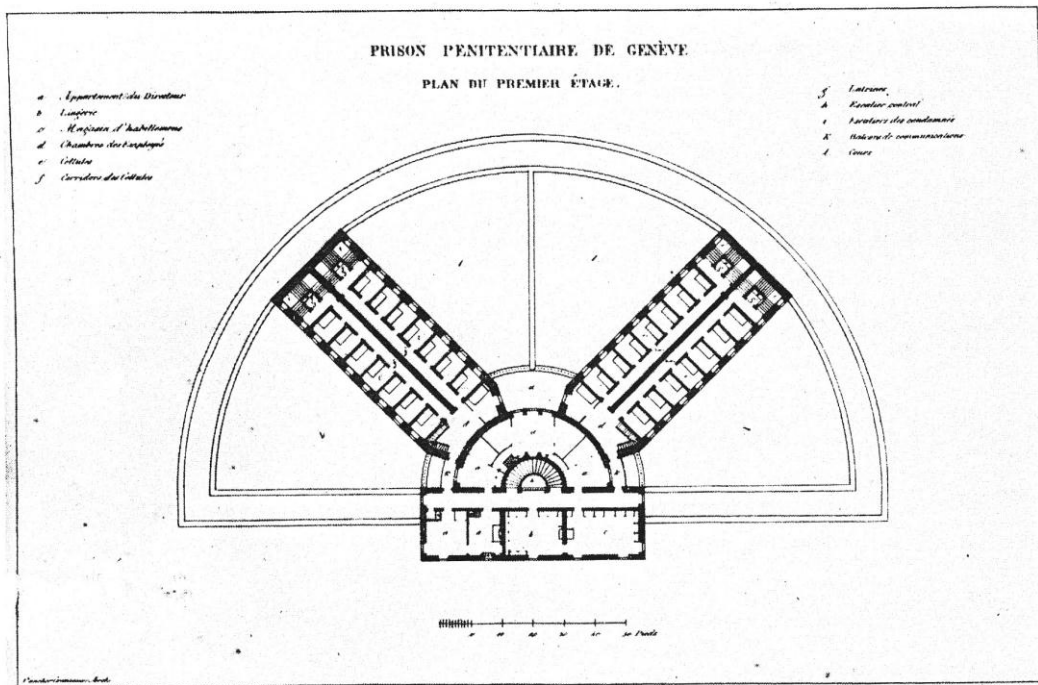

Figure 14: Tour Maitresse prison, Geneva, architect Samuel Vaucher-Crémieux, 1825: plan (Roth, *Pratiques Pénitentiaires et Théorie Sociale*, plate 4 following p.290)

Did the proposed Panopticon at Krichev have a radial plan?

A further and final question follows. Mary Sophia, as we have seen, wrote in 1856 that Samuel’s planned workshop at Krichev had ‘a centre from which diverged several long rays, all of them, on all the stories, capable of inspection from the central part’. Was she right about the ‘rays’? Or was she confused, and perhaps projecting back in time from the Okhta building – which she knew personally – to what she was assuming her husband had planned for Krichev? There is one more source that I have not yet introduced, which I would suggest goes a long way towards answering this question. This is an article ‘Arrangement of Buildings on Principles of Central Inspection’, published in *The Builder* in 1847 under the name of ‘The Late Sir Samuel Bentham’, but whose author must surely once again be Mary Sophia. This paper says of the Krichev workshop, that Samuel

contrived a structure having a central chamber for offices, with rays diverging from it for workshops. The rays were of two stories, the central observatory but of one floor, but that of such a height, that being upon it, the inspector had full view over two floors of the rays, the floor of the lower workshop being below that of the observatory, the floor of the upper workshop above it.⁵³

Mary Sophia—assuming she is indeed the author—goes on to describe how after Samuel returned to England in 1791, he had

complete models made on his principle of a prison for a thousand persons, in which, as the rays consisted of several floors, the upper ones were appropriate to services requiring the less constant inspection, but were subject to it at all times by means of a counterpoise apparatus affixed to the platform on which was the inspector's chair, so that at pleasure he could raise himself to any required height.⁵⁴

The detailed and circumstantial character of these accounts suggests to me at least that Mary Sophia was *not* mistaken about the geometry of the projected Krichev building, and that its plan was indeed radial. What is clear furthermore from the description of the models, is that in the 1790s while Jeremy, helped by Samuel, was persevering with his cylindrical plans, Samuel was also continuing to develop and press for radial designs like those of Okhta and—as readers may now be convinced—Krichev.

A third passage in this paper is yet more revealing. It quotes a paragraph by Jeremy from his twenty-first Panopticon letter, ‘as indicating the origin of Sir Samuel’s invention’.

In the Royal Military School at Paris, the bed-chambers (if my brother's [Samuel's] memory does not deceive him), form two ranges on the two sides of a long room; the inhabitants being separated from one another by *partitions*, but exposed alike to the view of a master at his walks, by a kind

⁵³ ‘The Late Sir Samuel Bentham’ [presumably Mary Sophia Bentham: Samuel is referred to in the third person throughout], ‘Arrangement of Buildings on Principles of Central Inspection’, *The Builder*, 30 October 1847, pp. 515–6.

⁵⁴ *Ibid.*, p. 515.

of *grated window* in each door. This plan of construction struck him, he tells me, a good deal, as he walked over that establishment [...] and possibly in that walk the foundation was laid for his Inspection-House. If he there borrowed his idea, I hope he has not repaid it without interest. You will confess some difference, in point of facility, betwixt a state of incessant walking, and a state of rest; and in point of completeness of inspection, between visiting two or three hundred persons one after another, and seeing them at once.⁵⁵

This is of course the precise distinction between the mode of inspection from the centre (the ‘state of rest’) in all of the Bentham brothers’ various buildings— although Samuel’s inspectors could move vertically—and the mobile form of inspection along straight halls (the ‘state of incessant walking’) that typified the Eastern Penitentiary, Pentonville and all their successors. The irony is that Jeremy sees Samuel’s change from mobile inspection to central inspection as an improvement. Had Samuel stuck more closely to what he had seen at the Royal Military School—and put peepholes in the place of the ‘grated windows’—he really would have anticipated the key features of the radial prison.

⁵⁵ ‘Panopticon Letter XXI’, Bowring, iv. p. 63.



This work is licensed under the Creative Commons Attribution-NonCommercial-NoDerivs 2.0 UK: England & Wales License. Under the terms of this licence, you are allowed to copy and distribute this work, but must give the original author credit. You not use this work for commercial purposes, nor alter or transform this work, without prior permission from the author. To view a full copy of this licence, visit: <http://creativecommons.org/licenses/by-nc-nd/2.0/uk/> or send a letter to Creative Commons, 444 Castro Street, Suite 900, Mountain View.